

# BENCHMADE

1995 - 1996 CATALOG

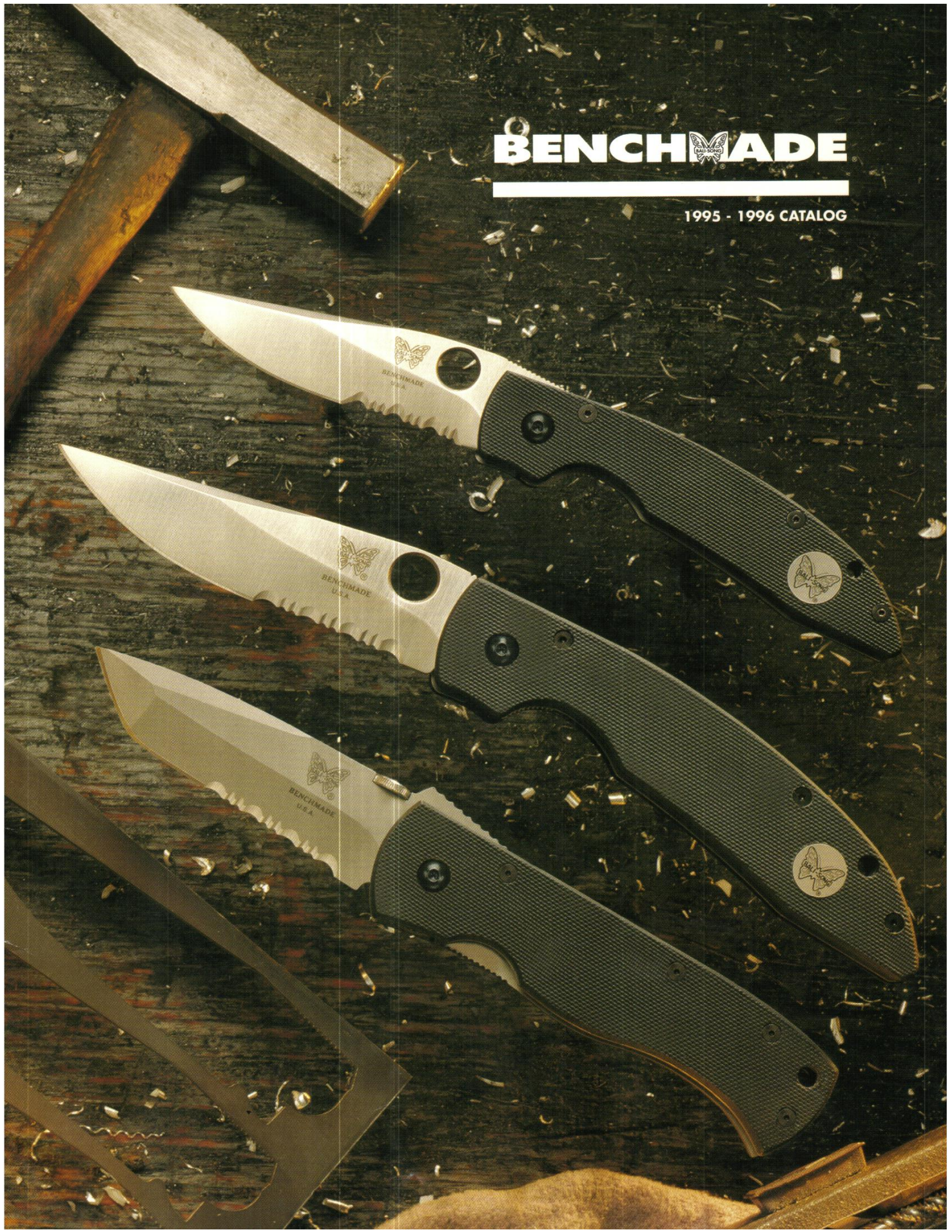



THE BENCHMADE PHILOSOPHY IS TO PRODUCE TOP-QUALITY KNIVES THAT WE, AS CONNOISSEURS, WOULD BE PROUD TO OWN AND USE. WE WILL ENSURE THAT EVERY BENCHMADE KNIFE OWNER HAS IN HIS HANDS THE MOST TRUSTWORTHY KNIFE FOUND ANYWHERE IN THE WORLD, AND TO CREATE AN ENVIRONMENT IN WHICH INNOVATION AND EXCELLENCE RATHER THAN PRODUCTION SPEED IS ENCOURAGED AND REWARDED.

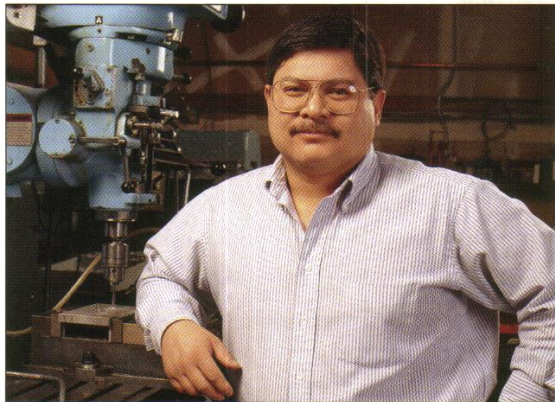

LES DEASIS, CEO - BENCHMADE KNIFE COMPANY INC.



# BENCHMADE BALI-SONG®

THE BEST IS BORN FROM HISTORY AND TRADITION.

THE BEST KNIFE BEGINS WITH A VISION...THAT OF THE CRAFTSMAN. IT'S IN THE DREAMS OF THE TRUE KNIFE LOVER THAT A GREAT KNIFE IS CONCEIVED. EVERY BENCHMADE KNIFE IS BUILT FOR THOSE WHO DEMAND AND RECOGNIZE THE BEST. AT BENCHMADE, THE BEST BEGAN WITH THE BALI-SONG®, THE BUTTERFLY KNIFE AWESOME IN ITS SIMPLICITY, THE ULTIMATE EXAMPLE OF FORM FOLLOWING FUNCTION. TODAY BENCHMADE CREATES A COMPREHENSIVE LINE OF ONE-HAND-OPERATED KNIVES, EVEN THE MOST SOPHISTICATED OF WHICH ECHO THE ATTRIBUTES OF OUR ORIGINAL BALI-SONG® — STRENGTH, SAFETY, DEPENDABILITY AND EASE OF USE. OF COURSE, WE STILL PRODUCE THE ORIGI-

NAL BALI-SONG® KNIFE. BUT TODAY WE CAN ALSO CUSTOMIZE THE CLASSIC CUSTOM MADE BALI-SONG® WITH NEW COMBINATIONS OF WEIGHT, SIZE AND FUNCTIONS. DELUXE CUSTOM FINISHES AND HAND SATIN POLISHED BLADES ARE AVAILABLE. HERE AT THE BENCHMADE FACTORY IN OREGON, THERE ARE NO LIMITS. YOU CAN COUNT THE CRAFTSMEN AT BENCHMADE AMONG THE MOST DEMANDING ANYWHERE. ONLY THE HIGHEST-QUALITY MATERIALS ARE USED. FROM THE TINIEST RIVET TO THE MOST ERGONOMICALLY DESIGNED HANDLE, EVERY BENCHMADE KNIFE IS MADE IN AMERICA AND MADE RIGHT THE FIRST TIME, EVERY TIME.





**CBS112 4" BOWIE CLIP BLADE**  
with Cocobolo inserts

**CBS129 5" WEEHAWK TANTO**  
with Stainless steel  
skeleton handles



**CBS200 6" SPEARPOINT BLADE**  
with Stainless steel  
skeleton handles



**CBS111 4" WEEHAWK BLADE**  
with white micarta inserts

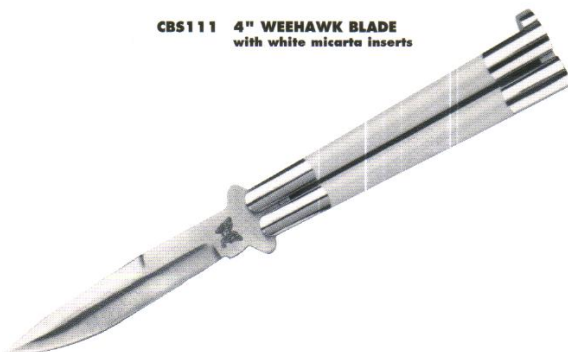

**CBS130 5" FILIPINO KRIS**  
with Stainless steel  
skeleton handles



**MODEL 35S - DELUXE FINISH SKELETONIZED STAINLESS STEEL**

**Blade**  
Length 3.0"  
Thickness 0.110"  
Material Sandvik stainless steel  
Hardness 57-59 HRC

**Overall Length** 7.5"  
**Size Closed** 4.375"  
**Handle** 17-4 PH investment cast stainless steel  
**Weight** 4.8 oz.  
**Warranty** Limited lifetime

**Model 35** With plain edged blade



**MODEL 10S - STANDARD FINISH SKELETONIZED STAINLESS STEEL**

**Blade**  
Length 3.0"  
Thickness 0.110"  
Material Sandvik stainless steel  
Hardness 57-59 HRC

**Overall Length** 7.5"  
**Size Closed** 4.375"  
**Handle** 17-4 PH investment cast stainless steel  
**Weight** 4.8 oz.  
**Warranty** Limited lifetime

**Model 10** With plain edged blade  
**Model 68** Deluxe finish with plain edged blade  
**Model 68S** Deluxe finish with ComboEdge

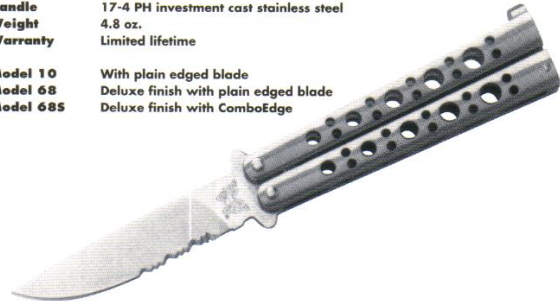

**MODEL 30S - STANDARD FINISH SKELETONIZED STAINLESS STEEL**

**Blade**  
Length 3.0"  
Thickness 0.110"  
Material Sandvik stainless steel  
Hardness 57-59 HRC

**Overall Length** 7.5"  
**Size Closed** 4.375"  
**Handle** 17-4 PH investment cast stainless steel  
**Weight** 4.8 oz.  
**Warranty** Limited lifetime

**Model 30** With plain edged blade



**MODEL 45S - DELUXE FINISH SKELETONIZED STAINLESS STEEL**

**Blade**  
Length 4.0"  
Thickness 0.110"  
Material Sandvik stainless steel  
Hardness 57-59 HRC

**Overall Length** 9.25"  
**Size Closed** 5.25"  
**Handle** 17-4 PH investment cast stainless steel  
**Weight** 5.0 oz.  
**Warranty** Limited lifetime

**Model 45** With plain edged blade



**MODEL 44S - DELUXE FINISH SKELETONIZED STAINLESS STEEL**

**Blade**  
Length 4.0"  
Thickness 0.110"  
Material G-2 stainless steel  
Hardness 57-59 HRC

**Overall Length** 9.25"  
**Size Closed** 5.25"  
**Handle** 17-4 PH investment cast stainless steel  
**Weight** 5.0 oz.  
**Warranty** Limited lifetime

**Model 44** With plain edged blade



**MODEL 48S - DELUXE FINISH SKELETONIZED STAINLESS STEEL**

**Blade**  
Length 4.0"  
Thickness 0.110"  
Material Sandvik stainless steel  
Hardness 57-59 HRC

**Overall Length** 9.25"  
**Size Closed** 5.25"  
**Handle** 17-4 PH investment cast stainless steel  
**Weight** 5.0 oz.  
**Warranty** Limited lifetime

**Model 48** With plain edged blade





**MODEL 239S - SKELETONIZED DIECAST ZAMAK HANDLES**

**Blade** Weehawk  
Length 4.0"  
Thickness 0.175"  
Material Sandvik stainless steel  
Hardness 57-59 HRC

**Overall Length** 9.25"  
**Size Closed** 5.25"  
**Handle** Zamak diecast nickel plated  
**Weight** 5.3 oz.  
**Warranty** Limited lifetime

**Model 239** With plain edged blade

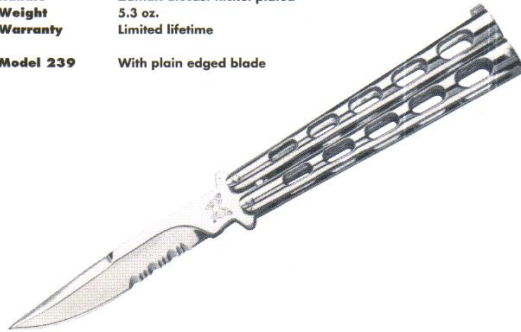

**MODEL 259S - DIECAST ZAMAK HANDLES WITH BLACK INSERTS**

**Blade** Weehawk  
Length 4.0"  
Thickness 0.175"  
Material Sandvik stainless steel  
Hardness 57-59 HRC

**Overall Length** 9.25"  
**Size Closed** 5.25"  
**Handle** Zamak diecast with black panel inserts  
**Weight** 6.8 oz.  
**Warranty** Limited lifetime

**Model 259** - With plain edged blade  
**Model 259 - Blk** Black with plain edged blade  
**Model 259S - Blk** Black with ComboEdge



**MODEL 239S - BLK - SKELETONIZED DIECAST ZAMAK HANDLES**

**Blade** Weehawk  
Length 4.0"  
Thickness 0.175"  
Material Sandvik stainless steel  
Hardness 57-59 HRC

**Overall Length** 9.25"  
**Size Closed** 5.25"  
**Handle** Zamak diecast with black powder-coat  
**Weight** 5.3 oz.  
**Warranty** Limited lifetime

**Model 239 - Blk** Black with plain edged blade



**MODEL 139S - SKELETONIZED DIECAST ZAMAK HANDLES**

**Blade** Utility  
Length 4.0"  
Thickness 0.175"  
Material Sandvik stainless steel  
Hardness 57-59 HRC

**Overall Length** 9.25"  
**Size Closed** 5.25"  
**Handle** Zamak diecast nickel plated  
**Weight** 5.3 oz.  
**Warranty** Limited lifetime

**Model 139** - With plain edged blade  
**Model 139 - Blk** Black with plain edged blade  
**Model 139S - Blk** Black with ComboEdge

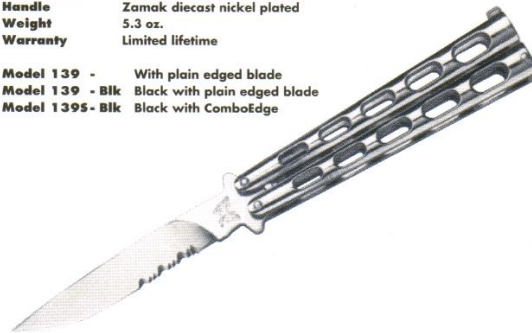

**MODEL 159S - DIECAST ZAMAK HANDLES WITH BLACK INSERTS**

**Blade** Utility  
Length 4.0"  
Thickness 0.175"  
Material Sandvik stainless steel  
Hardness 57-59 HRC

**Overall Length** 9.25"  
**Size Closed** 5.25"  
**Handle** Zamak diecast with black panel inserts  
**Weight** 6.8 oz.  
**Warranty** Limited lifetime

**Model 159** With plain edged blade



**MODEL 159S - BLK - DIECAST ZAMAK HANDLES WITH BLACK INSERTS**

**Blade** Utility  
Length 4.0"  
Thickness 0.175"  
Material Sandvik stainless steel  
Hardness 57-59 HRC

**Overall Length** 9.25"  
**Size Closed** 5.25"  
**Handle** Zamak diecast black powder coat with black panel inserts  
**Weight** 6.8 oz.  
**Warranty** Limited lifetime

**Model 159 - Blk** Black with plain edged blade



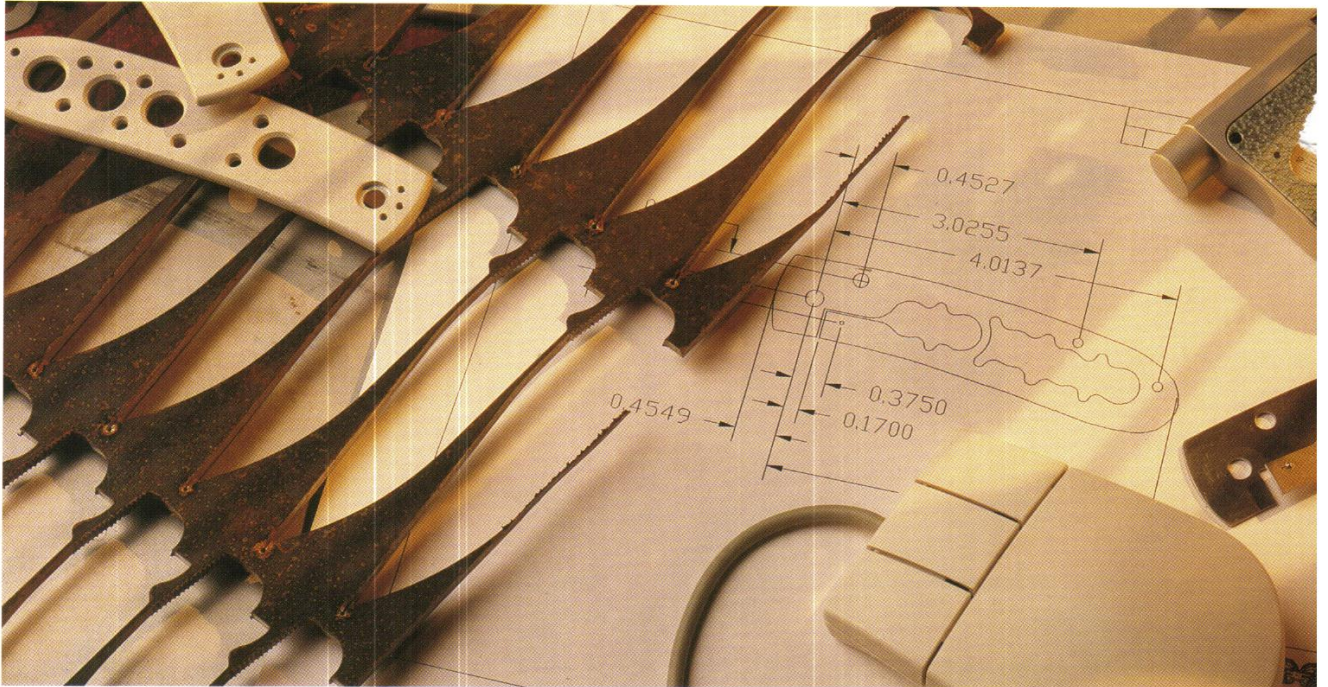

# BENCHMADE DESIGNER SERIES

CUSTOM-DESIGNED KNIVES  
WITH A TECHNOLOGICAL EDGE.

THE BENCHMADE DESIGNER SERIES IS BUILT ON A FOUNDATION OF RESPECT FOR THE CUSTOM KNIFE MAKER. WE APPLAUD THE TALENT, THE PASSION AND THE DREAMS OF TOP-NOTCH MAKERS, MEN WHO CONCEIVE AND CREATE ONE KNIFE AT A TIME. BUT AT BENCHMADE OUR GOAL IS TO MAKE THOSE DREAMS ATTAINABLE REALITIES—REALITIES THAT CAN BE HELD, USED AND TRUSTED BY EVERY ONE. THAT'S BECAUSE BENCHMADE CREATES MAN'S OLDEST TOOLS USING MAN'S NEWEST TECHNOLOGY. OUR CLOSE ASSOCIATION WITH THE WORLD'S PREMIER CUSTOM KNIFE MAKERS WHO ARE CONSTANTLY EXPLORING NEW LOCKING DESIGNS, MATERIALS AND PROCESSES ASSURES OUR

CUSTOMERS THAT BENCHMADE PRODUCTS TRULY DEFINE STATE OF THE ART. FROM SCREWS AND RIVETS TO THE LATEST IN LASER TECHNOLOGY, EVERY COMPONENT AND EVERY PIECE OF EQUIPMENT IS MADE OR ADAPTED TO FIT OUR UNRELENTING PRODUCTION STANDARDS. IF THE RIGHT MACHINE TO DO THE JOB DOESN'T EXIST, WE MAKE IT. THIS IS THE LEVEL OF OUR PERSISTENCE AND DETERMINATION IN THE PURSUIT OF QUALITY. THE RESULT IS A CUSTOM-DESIGNED KNIFE WITH THE SOUL OF THE ORIGINAL AND THE PRECISE CHARACTER OF HIGH TECHNOLOGY UNEQUALED IN OUR INDUSTRY. DEMAND THE BEST. DEMAND BENCHMADE.





**Pat Crawford Leopard and Leopard Cub**

OUR CLASSIC PAT CRAWFORD DESIGNED KNIFE PROVIDES ALL THE STRENGTH AND FUNCTIONALITY YOU COULD WANT IN A POCKET KNIFE.

COMPLETE WITH POCKET CLIP AND ATS-34 STAINLESS STEEL BLADE. ONE OF THE MOST UNIQUE POCKET KNIVES AROUND!



All Designer series knives come standard with pocket clip



**MODEL 6255 - PAT CRAWFORD LEOPARD**  
with locking liner and pocket clip

**Blade**  
Length 3.75"  
Thickness 0.125"  
Material ATS-34 stainless steel, satin finish  
Hardness 59-61 HRC

**Overall Length** 8.125"  
**Size Closed** 4.56"  
**Handle** 6061 T-6 Aluminum  
Available in grey or black  
Anodized aluminum  
3.9 oz.

**Weight**  
**Warranty** Limited lifetime

**Model 625** With plain edged blade  
**Model 625 - Blk** With plain edged blade  
**Model 6255 - Blk** With ComboEdge



**MODEL 6125 - PAT CRAWFORD LEOPARD CUB**  
with locking liner and pocket clip

**Blade**  
Length 2.875"  
Thickness 0.100"  
Material ATS-34 stainless steel, satin finish  
Hardness 59-61 HRC

**Overall Length** 6.78"  
**Size Closed** 3.81"  
**Handle** 6061 T-6 Aluminum  
Available in grey or black  
Anodized aluminum  
2.3 oz.

**Weight**  
**Warranty** Limited lifetime

**Model 612** With plain edged blade  
**Model 612 - Blk** With plain edged blade  
**Model 6125 - Blk** With ComboEdge



## THE PHIL BOGUSZEWSKI SPIKE

DESIGNED BY CUSTOM KNIFE MAKER PHIL BOGUSZEWSKI, THIS KNIFE DESIGN CONTINUES TO BE ONE OF THE MOST POPULAR KNIVES IN OUR CUSTOM DESIGNER SERIES. THIS MODERN CLASSIC URBAN FOLDER FEATURES A RAZOR SHARP BLADE, SYMMETRICALLY TAPERED HANDLE AND OUR UNIQUE SMOOTH-AS-SILK LOCKING MECHANISM.

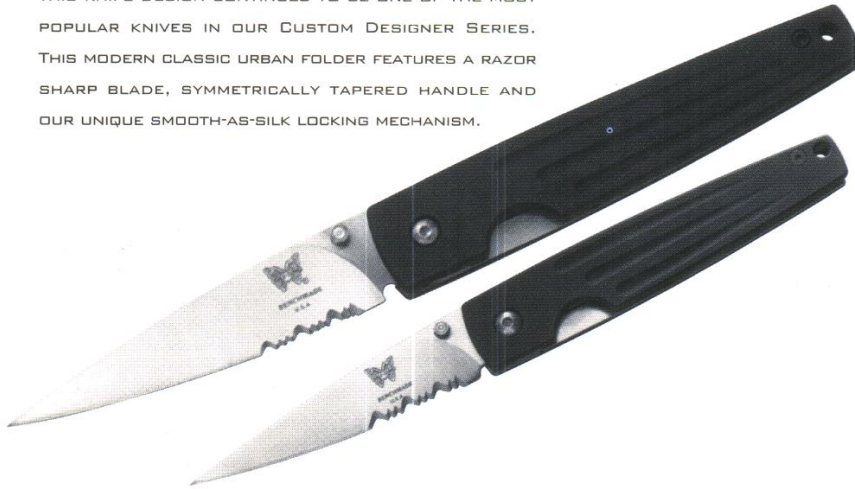

### MODEL 650S - PHIL BOGUSZEWSKI SPIKE with locking liner and pocket clip

**Blade**  
Length 4.1"  
Thickness 0.125"  
Material ATS-34 stainless steel, satin finish  
Hardness 59-61 HRC

**Overall Length** 9.33"  
**Size Closed** 5.23"  
**Handle** 6061 T-6 Aluminum  
black anodized aluminum  
**Liner** T-410 Stainless steel  
**Weight** 4.2 oz.  
**Warranty** Limited lifetime

**Model 650** With plain edged blade

### MODEL 640S - PHIL BOGUSZEWSKI MINI SPIKE with locking liner and pocket clip

**Blade**  
Length 3.125"  
Thickness 0.100  
Material ATS-34 stainless steel, satin finish  
Hardness 59-61 HRC

**Overall Length** 7.312"  
**Size Closed** 4.250"  
**Handle** 6061 T-6 Aluminum  
black anodized aluminum  
**Liner** T-410 Stainless steel  
**Weight** 3.0 oz.  
**Warranty** Limited lifetime

**Model 640** With plain edged blade

## THE ERNEST EMERSON - CQC7

DESIGNED BY ERNEST EMERSON THIS IS ONE OF OUR NEWEST ADDITIONS TO OUR CUSTOM DESIGNER SERIES. THIS HIGH-TECH CLOSE QUARTER COMBAT FOLDING KNIFE FEATURES TITANIUM LINERS G-10 HIGH PRESSURE LAMINATE SCALES AND ATS-34 STEEL, WITH A NEW CHISEL GROUND BLADE. DESTINED TO BE ONE OF THE BEST TACTICAL KNIVES AROUND!

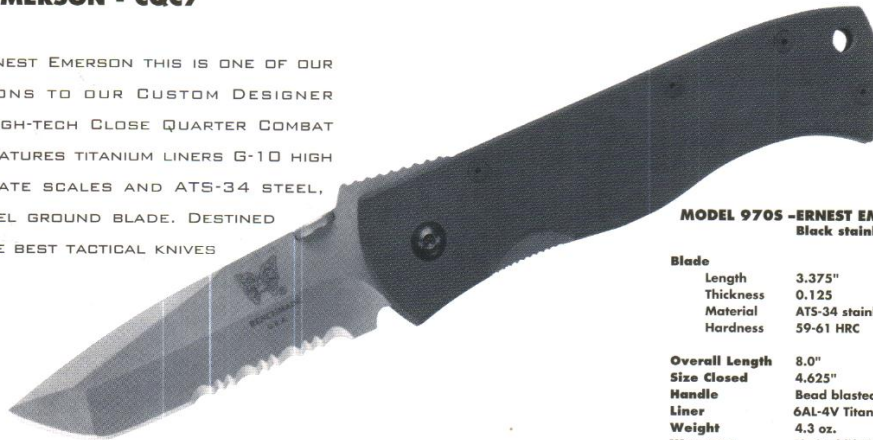

### MODEL 970S - ERNEST EMERSON DESIGN CQC7 Black stainless pocket clip

**Blade**  
Length 3.375"  
Thickness 0.125  
Material ATS-34 stainless steel, bead blasted  
Hardness 59-61 HRC

**Overall Length** 8.0"  
**Size Closed** 4.625"  
**Handle** Bead blasted G-10 scales  
**Liner** 6AL-4V Titanium  
**Weight** 4.3 oz.  
**Warranty** Limited lifetime

**Model 970** With plain edged blade

## THE WALTER BREND COMBAT TALON II

THE MODEL 600 IS OUR ADAPTATION OF WALTER BREND'S RUGGED AWARD WINNING NO.2 COMBAT KNIFE AND FEATURES HIS EXCEPTIONALLY SHARP REVERSE CURVE BLADE FOR THE ULTIMATE IN CUTTING PERFORMANCE. IT'S FEATURES INCLUDE ATS-34 BLADE STEEL, A HEAT TREATED T-410 STAINLESS LINER AND A STAINLESS STEEL POCKET CLIP.

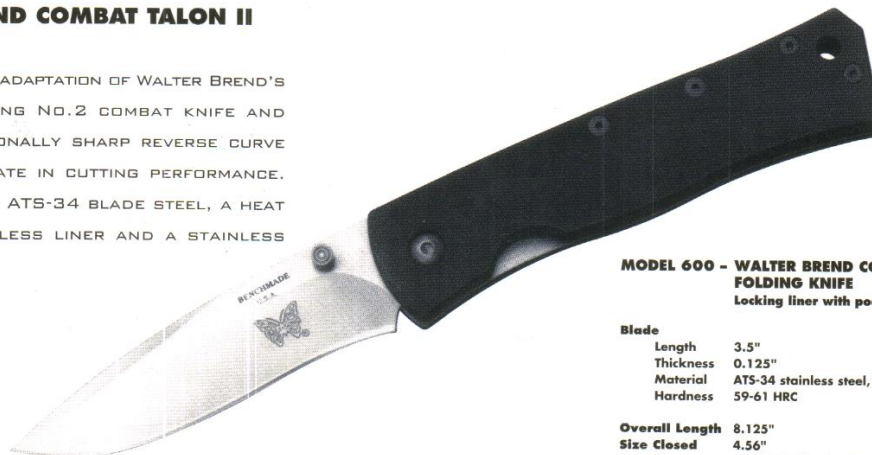

### MODEL 600 - WALTER BREND COMBAT TALON II FOLDING KNIFE Locking liner with pocket clip

**Blade**  
Length 3.5"  
Thickness 0.125"  
Material ATS-34 stainless steel, satin finish  
Hardness 59-61 HRC

**Overall Length** 8.125"  
**Size Closed** 4.56"  
**Handle** 6061 T-6 Aluminum  
Black anodized  
**Liner** T-410 Stainless steel  
**Weight** 3.9 oz.  
**Warranty** Limited lifetime



## THE AFCK (ADVANCED FOLDING COMBAT KNIFE) AND MINI AFCK

YOU'VE ASKED FOR IT, NOW WE HAVE IT! THIS DUTY KNIFE, DESIGNED IN CONJUNCTION WITH GUNSITE TRAINING CENTER INSTRUCTOR CHRIS CARACCI AND LICENSED BY SPYDERCO® INC, WILL BE ONE OF THE MOST POPULAR HIGH-TECH TACTICAL KNIVES YOU HAVE SEEN. BOTH KNIVES FEATURE G-10 HIGH PRESSURE LAMINATE SCALES AND ATS-34 BLADE STEEL. THE 800 ALSO HAS TITANIUM LINERS.

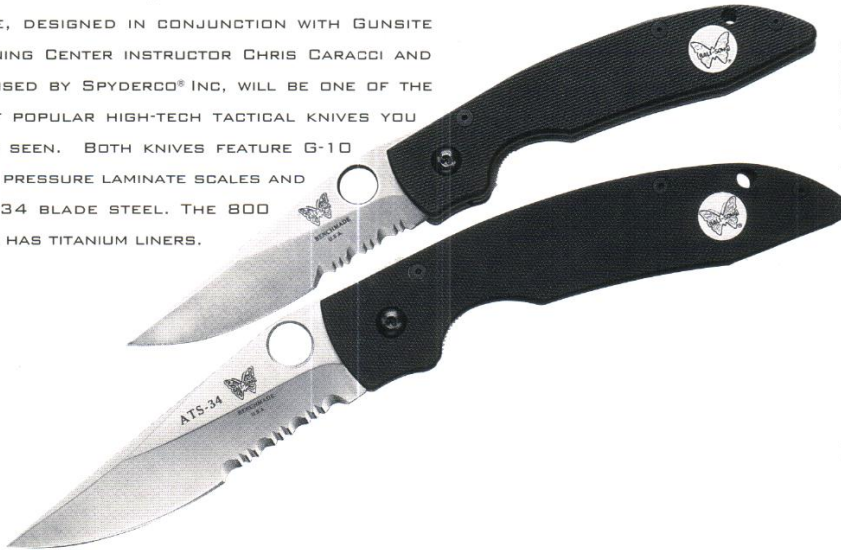

### MODEL 812S - MINI ADVANCED FOLDING COMBAT KNIFE (AFCK) Black stainless pocket clip

**Blade**  
Length 3.25"  
Thickness 0.100"  
Material ATS-34 stainless steel, satin finish  
Hardness 59-61 HRC

**Overall Length** 7.0"  
**Size Closed** 4.625"  
**Handle** Bead blasted G-10 scales  
**Liner** T-410 Stainless steel  
**Weight** 3.0 oz.  
**Warranty** Limited lifetime

**Model 812** With plain edged blade

### MODEL 800S - ADVANCED FOLDING COMBAT KNIFE (AFCK) Black stainless pocket clip

**Blade**  
Length 3.9"  
Thickness 0.125"  
Material ATS-34 stainless steel, satin finish  
Hardness 59-61 HRC

**Overall Length** 9.0"  
**Size Closed** 5.0"  
**Handle** Bead blasted G-10 scales  
**Liner** 6AL-4V Titanium  
**Weight** 4.1 oz.  
**Warranty** Limited lifetime

**Model 800** With plain edged blade

## THE TSUNAMI

THIS KNIFE COMBINES THE LEGENDARY JAPANESE ARMOR PIERCING BLADE SHAPE WITH A MODERN ERGONOMICALLY DESIGNED HANDLE. THE TANTO BLADE SHAPE FEATURES A THICK, FULL STRENGTH BACKBONE PROVIDING AN EDGE AND POINT GEOMETRY PROVEN AND REFINED OVER SEVERAL HUNDRED YEARS.

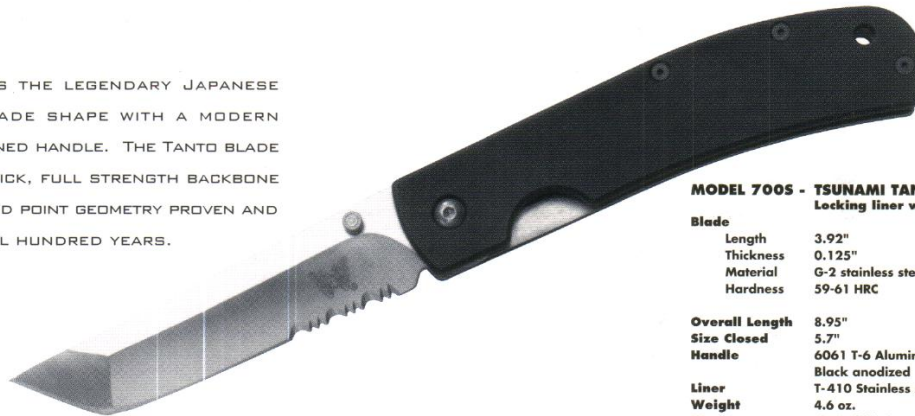

### MODEL 700S - TSUNAMI TANTO Locking liner with pocket clip

**Blade**  
Length 3.92"  
Thickness 0.125"  
Material G-2 stainless steel, satin finish  
Hardness 59-61 HRC

**Overall Length** 8.95"  
**Size Closed** 5.7"  
**Handle** 6061 T-6 Aluminum  
Black anodized  
**Liner** T-410 Stainless steel  
**Weight** 4.6 oz.  
**Warranty** Limited lifetime

**Model 700** With plain edged blade

## THE KODIAK SKINNER

THE KODIAK SKINNER COMBINES A TRADITIONAL LARGE CLASSIC FIELD BOWIE BLADE SHAPE WITH ERGONOMICALLY DESIGNED HANDLES. THE KODIAK SKINNER SHOWCASES OUR ABILITY TO OFFER A LARGER BLADE SHAPE IN A SMALLER SIZED PACKAGE. PERFECT FOR SKINNING, CAPING, AND ALL FIELD USES. THIS KNIFE HAS BECOME THE FAVORITE OF MANY SERIOUS OUTDOOR ENTHUSIASTS WHO DEMAND MAXIMUM PERFORMANCE.

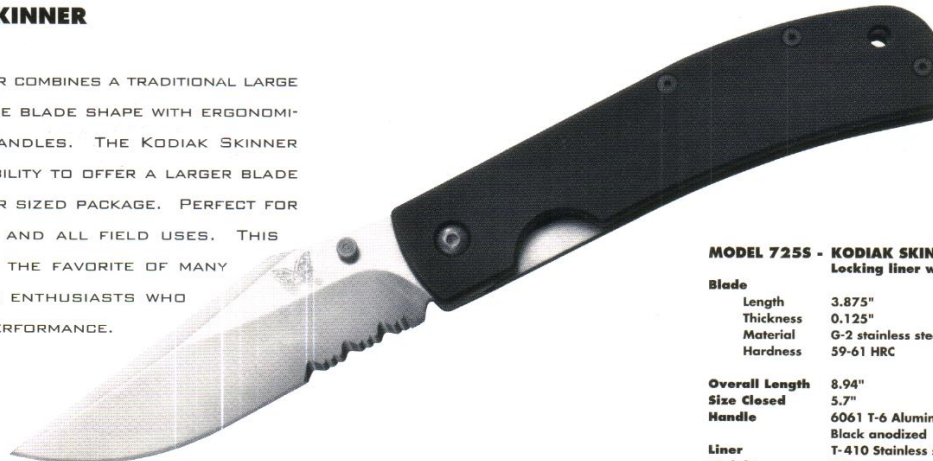

### MODEL 725S - KODIAK SKINNER Locking liner with pocket clip

**Blade**  
Length 3.875"  
Thickness 0.125"  
Material G-2 stainless steel, satin finish  
Hardness 59-61 HRC

**Overall Length** 8.94"  
**Size Closed** 5.7"  
**Handle** 6061 T-6 Aluminum  
Black anodized  
**Liner** T-410 Stainless steel  
**Weight** 4.7 oz.  
**Warranty** Limited lifetime

**Model 725** With plain edged blade





# BENCHMADE LIGHTWEIGHTS

GREAT HANDS PUT A GREAT KNIFE IN YOUR HANDS.

THE CONVERGENCE OF NEW TECHNOLOGY AND MATERIALS WITH OLD TRADITION AND CRAFTSMANSHIP RESULTS IN GREAT DESIGN, BALANCE AND PERFORMANCE. AT BENCHMADE, LOVE OF THE WORK AND PRIDE IN THE WORKMANSHIP COMES GLEAMING THROUGH IN EVERY KNIFE. COMPUTER-CONTROLLED EQUIPMENT DELIVERS TECHNOLOGICAL PERFECTION AND TAKES AWAY THE DRUDGERY, FREEING HIGHLY SKILLED, HIGHLY MOTIVATED PEOPLE TO DO THE HANDWORK. LOTS OF COMPANIES TALK ABOUT TEAMWORK. AT BENCHMADE WE WALK OUR TALK. BENCHMADE'S PROFESSIONAL STAFF IS COMPOSED OF INDIVIDUALS WHO HAVE YEARS OF EXPERIENCE AT EVERY LEVEL OF KNIFE-MAKING. EVERYONE KNOWS THE INTERLOCKING RELATIONSHIPS THAT GO INTO CREATING A TOP-QUALITY KNIFE. EACH COMPONENT IS INSPECTED AT EVERY STEP OF THE WAY BY INDIVIDUALS AS WELL AS COMPUTERIZED INSPECTION EQUIPMENT. EACH PHASE OF

PRODUCTION IS CAREFULLY AUDITED BY WATCHFUL, KNOWLEDGEABLE EYES. PRECISION FINISHWORK IS DONE BY HAND. EVERY KNIFE IS GIVEN THAT FINAL HUMAN FINISHING TOUCH WITH EXPERT HAND SHARPENING. HERE THE MOTTO IS "WE CAN DO IT RIGHT." THAT'S WHY EVERY BENCHMADE KNIFE HAS A LIFETIME GUARANTEE ON MATERIALS AND WORKMANSHIP. WE COMBINE THE FINEST IN RAW MATERIALS, ENGINEERING AND MOST IMPORTANTLY THE HUMAN TOUCH. EXPERIENCE ONE OF OUR BENCHMADE LIGHTWEIGHTS. NOTICE THE BALANCE. MARVEL AT HOW SMOOTHLY IT OPERATES. EXAMINE THE EXTRAORDINARY STRENGTH AND SHARPNESS. THE QUALITY IS TANGIBLE. AND THE EXPERTS AT BENCHMADE HAVE DONE THEIR WORK—RESEARCH, DESIGN, PRODUCT-TESTING, CRAFTSMANSHIP—TO ENSURE QUALITY THAT LASTS A LIFETIME.





**MODEL 401S - PANTHER FOLDING KNIFE**  
With thumb stud

**Blade**  
Length 3.25"  
Thickness 0.125"  
Material G-2 stainless steel  
Hardness 57-59 HRC

**Overall Length** 7.625"  
**Size Closed** 4.375"  
**Handle** Black matte zytel  
**Weight** 2.8 oz.  
**Warranty** Limited lifetime

**Model 401** With plain edged blade



**MODEL 400S - PANTHER FOLDING KNIFE**  
With thumb stud

**Blade**  
Length 3.25"  
Thickness 0.125"  
Material G-2 stainless steel  
Hardness 57-59 HRC

**Overall Length** 7.625"  
**Size Closed** 4.375"  
**Handle** Black matte zytel  
**Weight** 2.8 oz.  
**Warranty** Limited lifetime

**Model 400** With plain edged blade

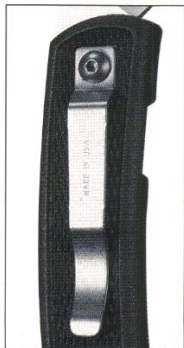

All Panther designs  
come standard with pocket clip

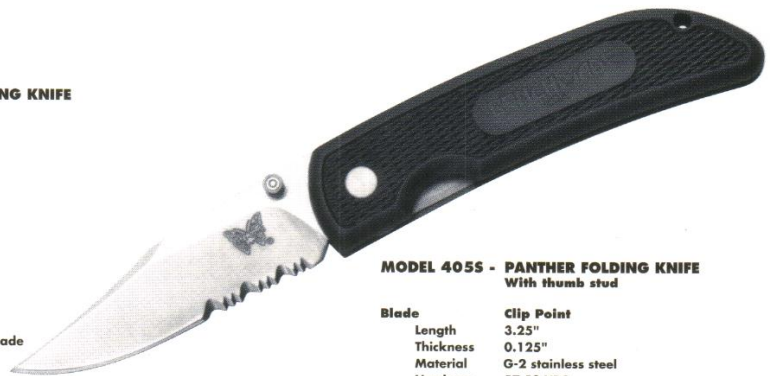

**MODEL 405S - PANTHER FOLDING KNIFE**  
With thumb stud

**Blade**  
Length 3.25"  
Thickness 0.125"  
Material G-2 stainless steel  
Hardness 57-59 HRC

**Overall Length** 7.625"  
**Size Closed** 4.375"  
**Handle** Black matte zytel  
**Weight** 2.8 oz.  
**Warranty** Limited lifetime

**Model 405** With plain edged blade

**MODEL 501S - MONARCH FOLDING HUNTING KNIFE**  
 Ambidextrous thumb disk, rear lock,  
 includes black nylon belt sheath

**Blade** Weehawk  
 Length 3.5"  
 Thickness 0.125"  
 Material Sandvik stainless steel  
 Satin finish  
 Hardness 57-59 HRC

**Overall Length** 8.5"  
**Size Closed** 4.875"  
**Handle** Zytel inner frame with textured Kraton inserts  
**Weight** 3.2 oz.  
**Warranty** Limited lifetime

**Model 501** With plain edged blade

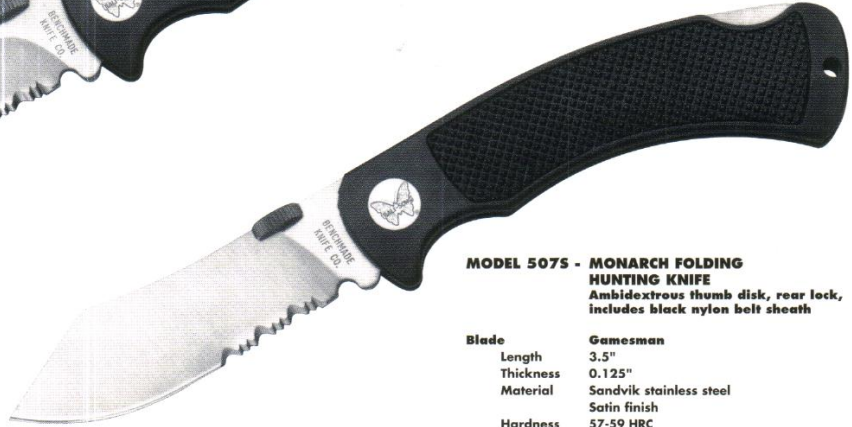

**MODEL 507S - MONARCH FOLDING HUNTING KNIFE**  
 Ambidextrous thumb disk, rear lock,  
 includes black nylon belt sheath

**Blade** Gamesman  
 Length 3.5"  
 Thickness 0.125"  
 Material Sandvik stainless steel  
 Satin finish  
 Hardness 57-59 HRC

**Overall Length** 8.5"  
**Size Closed** 4.875"  
**Handle** Zytel inner frame with textured Kraton inserts  
**Weight** 3.2 oz.  
**Warranty** Limited lifetime

**Model 507** With plain edged blade

**MODEL 500S - MONARCH FOLDING HUNTING KNIFE**  
 Rear lock, includes black nylon sheath

**Blade** Utility  
 Length 3.5"  
 Thickness 0.125"  
 Material Sandvik stainless steel  
 Satin finish  
 Hardness 57-59 HRC

**Overall Length** 8.5"  
**Size Closed** 4.875"  
**Handle** Zytel inner frame with textured Kraton inserts  
**Weight** 3.2 oz.  
**Warranty** Limited lifetime

**Model 500** With plain edged blade

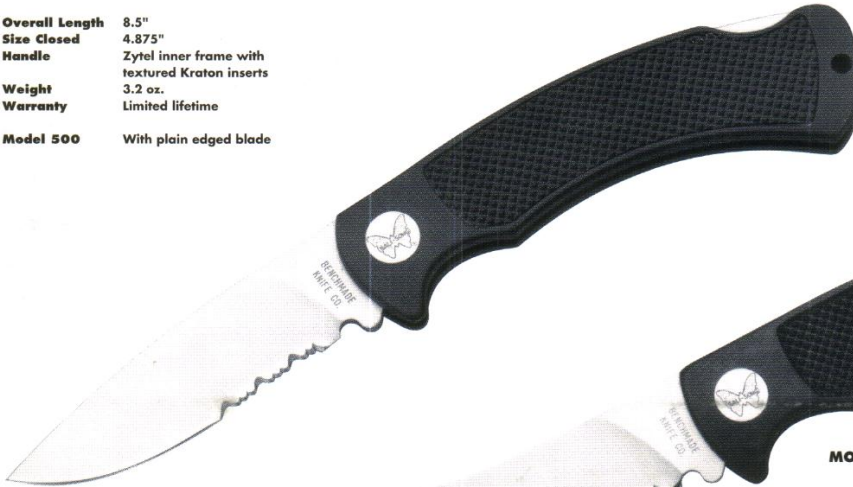

**MODEL 505S - MONARCH FOLDING HUNTING KNIFE**  
 Rear lock, includes black nylon sheath

**Blade** Gamesman  
 Length 3.5"  
 Thickness 0.125"  
 Material Sandvik stainless steel  
 Satin finish  
 Hardness 57-59 HRC

**Overall Length** 8.5"  
**Size Closed** 4.875"  
**Handle** Zytel inner frame with textured Kraton inserts  
**Weight** 3.2 oz.  
**Warranty** Limited lifetime

**Model 505** With plain edged blade



